

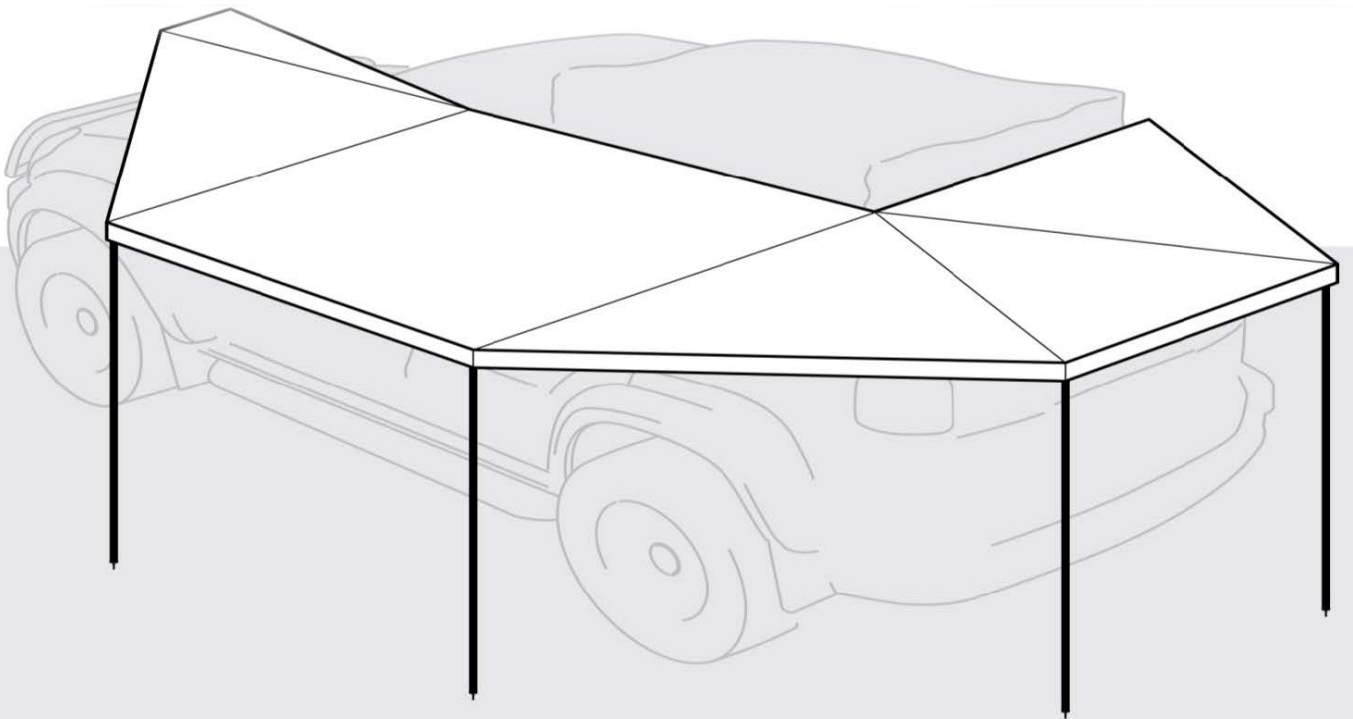

Nomadic 270° Awning



**CAREFULLY READ INSTRUCTIONS PRIOR
TO THE FIRST USE OF THE 270° AWNING**

GET TO KNOW YOUR AWNING

We recommend you check all parts are included prior to first use.

Box 1

1 270° Awning
 6 Twist-lock leg poles
(3 in a canvas bag)

Box 2

6 25mm M8 mounting bolts and nuts
 3 Mounting bracket
 1 Neoprene Sleeve

6 'U' Bolts with nuts and washers
 2 Tension straps
 13 Pegs

13 Guy ropes
 3 T- Slot Brackets

Tools needed

1 13mm Wrench

ATTACHING BRACKET TO ROOF-RACK

1

270° awning brackets have been designed to fit most common roof rack configurations. However, with the ever increasing numbers of roof rack designs available, it is difficult to supply a mounting bracket to accommodate every case. Below are examples of how to mount the Awning brackets to Flat style and

Basket style roof racks. The bracket can also be mounted on roof bars, however, additional specific attachments may need to be sourced from your roof rack supplier.

If in doubt, please visit your roof rack specialist for specific roof rack mounting options and advise on Load capacities

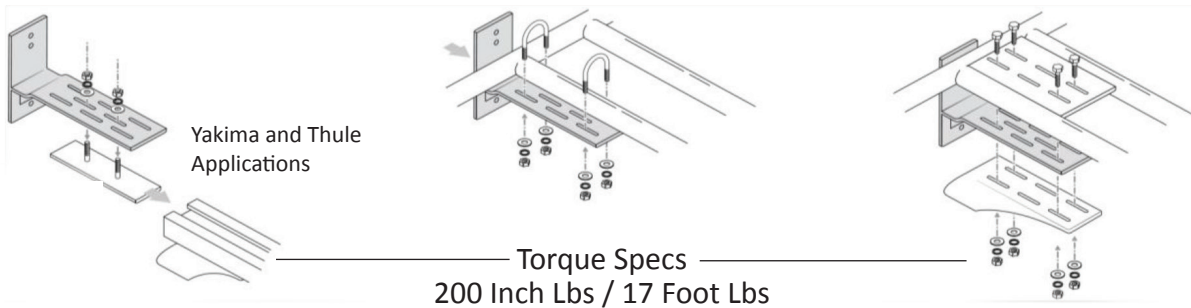

ATTACH AWNING TO BRACKET

We recommend using an experienced after-market 4x4 Accessories fitter to mount the Awning to your vehicle. Fasteners and fixing connections should be checked regularly on both the awning and roof rack to ensure the awning is always mounted securely to your vehicle roof rack.



PROLONGED TRAVELING ON UNEVEN ROUGH OR CORRUGATED TERRAIN WILL REQUIRE MORE FREQUENT INSPECTIONS.

2

Insert supplied 25mm M8 bolts into grooves in aluminum backing plate.

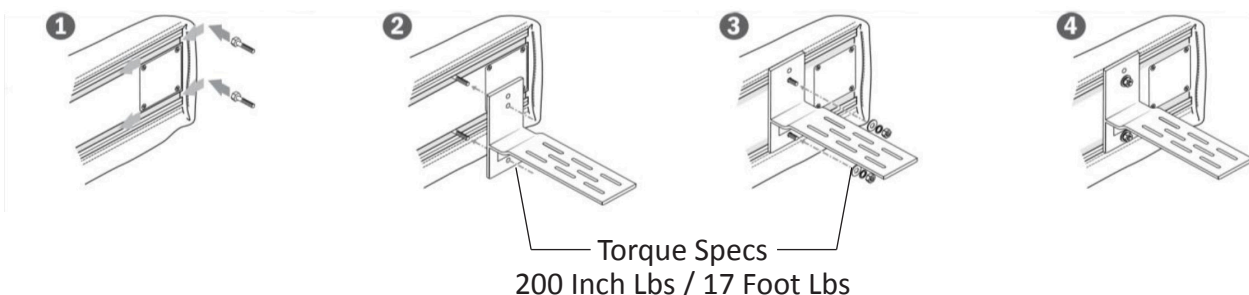

Nomadic 270° Awning

SET-UP & CARE INSTRUCTIONS

SET-UP

3

REMOVE COVER

Unzip cover and fold it over the awning body

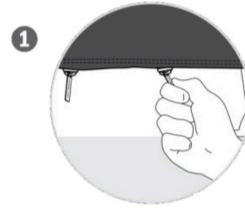
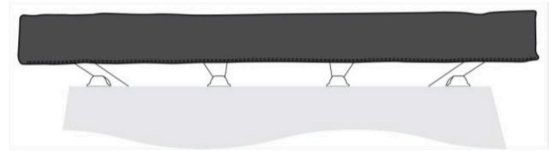

2

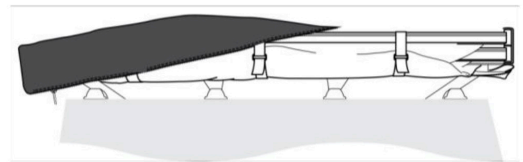

4

RELEASE AWNING

Release the three Velcro straps and allow canvas to drape

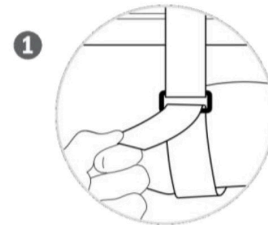

2

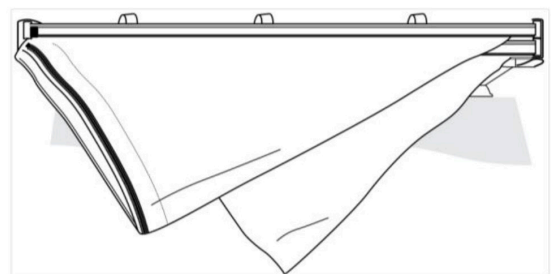

Nomadic 270° Awning

SET-UP & CARE INSTRUCTIONS

SET-UP

5

OPENING

To begin setting up the awning follow steps 1 to 4

TIP

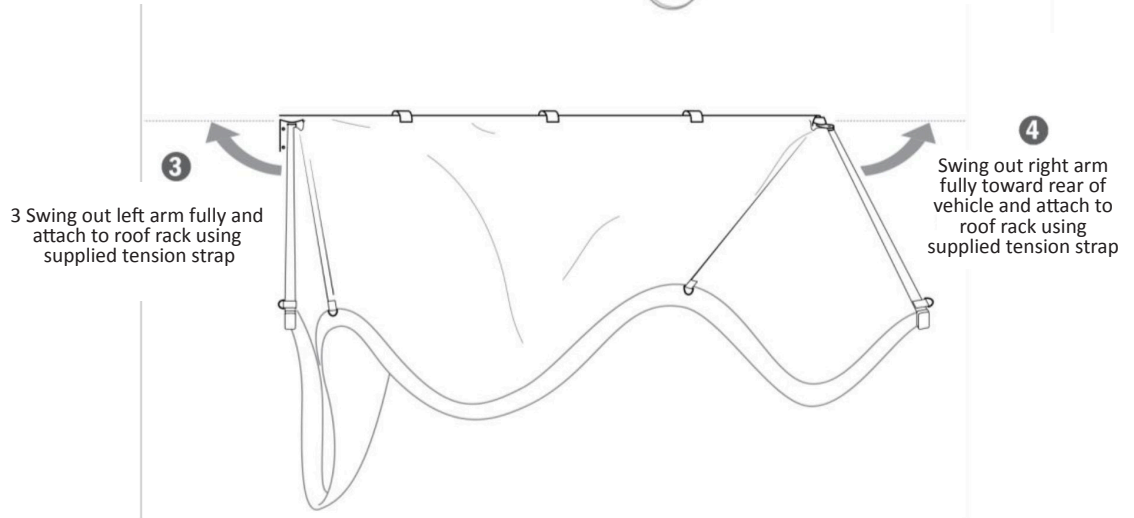
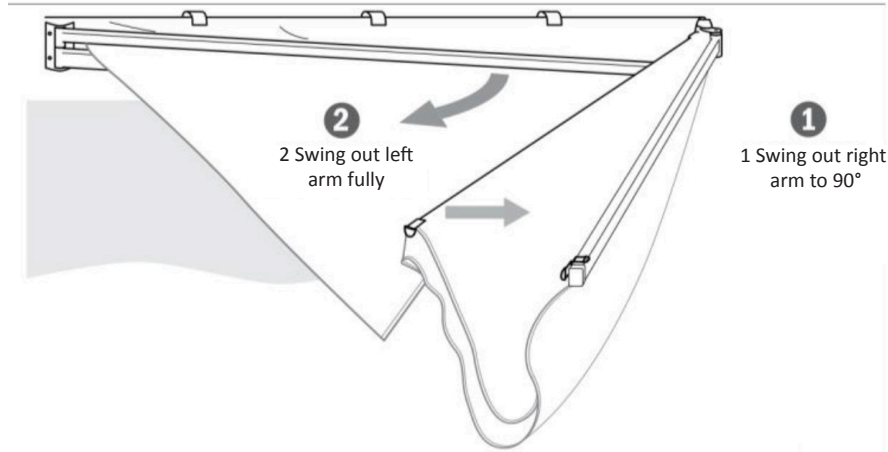

5

INSERT STRAP INTO OPTIONAL NEOPRENE SLEEVE IF APPLICABLE



THE NEOPRENE SLEEVE IS DESIGNED TO PROTECT THE VEHICLE'S PAINT FROM BEING WORN DOWN WHILE THE PRODUCT IS IN USE.

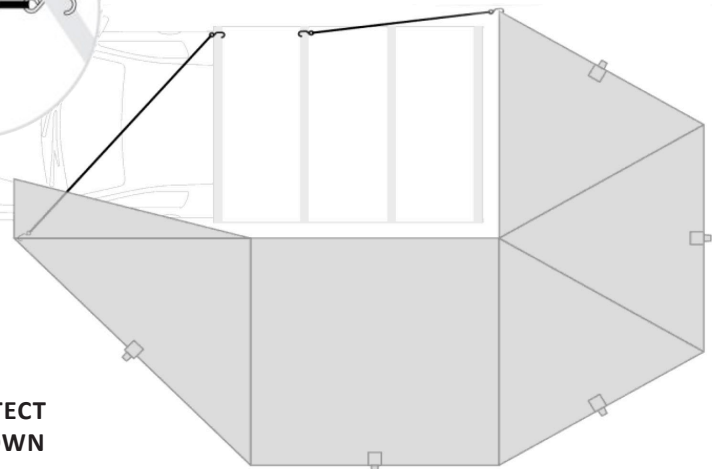

Nomadic 270° Awning

SET-UP & CARE INSTRUCTIONS

6

SET-UP

POLE SET-UP

- Undo the Velcro straps securing each support leg. Leg will pivot down to a vertical position. Adjust to desired height by unlocking and locking the internal twist locking mechanism.
- Attach individual support legs to the remaining rafters by inserting into holes at the end of each rafter.
- Secure the end of each rafter by anchoring and tensioning guy ropes.

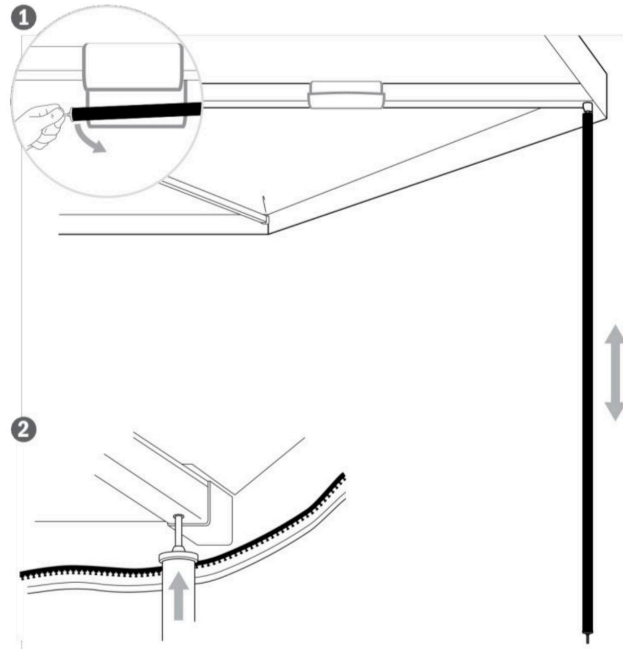

ENSURE ALL GUIDE ROPES ARE SECURED



IF ATTACHING OPTIONAL WALLS, EACH RAFTER MUST BE SUPPORTED BY A POLE.

UPDATING POLES FOR TRANSIT VANS

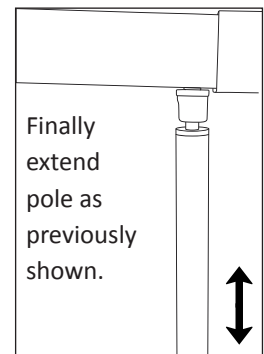
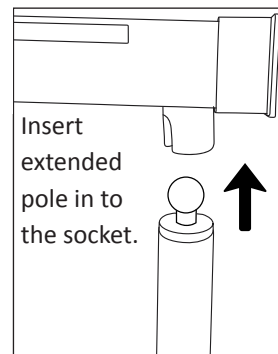
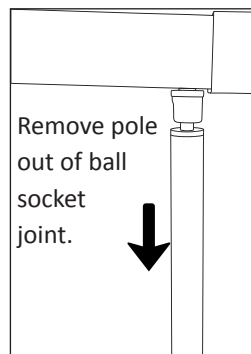

TIP

IN CASE OF RAIN, LOWER THE SUPPORT LEGS TO ALLOW DOWNWARD SLOPE AND GUY OFF BETWEEN RAFTERS TO FORM VALLEYS FOR WATER RUN—OFF

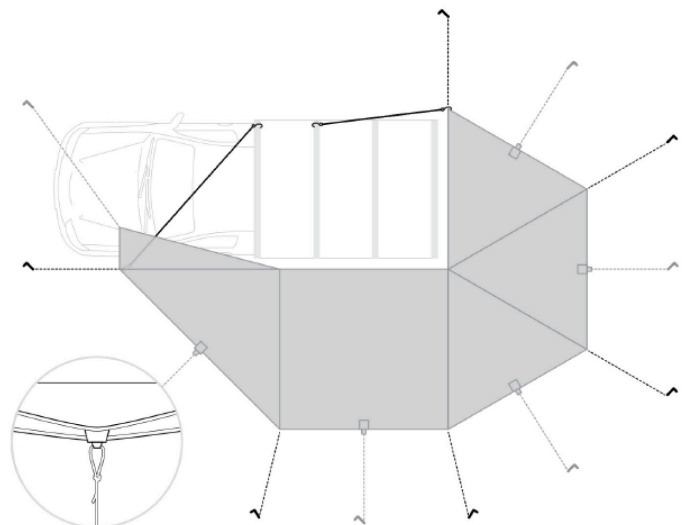

Nomadic 270° Awning

SET-UP & CARE INSTRUCTIONS

7

PACK-DOWN

- Undo all pegs / guy ropes
- Fold away legs and stow away using attached Velcro straps
- Stow 3 x additional legs in canvas carry bag.
- Release front and rear tension strap.
- Fold the RHS of awning back 90° from the awning body ensuring the top rafters sit directly on top of the bottom rafters.
- Fold the LHS of awning back 90° from the awning body ensuring the top rafters sit directly on top of the bottom rafters.
- Roll canvas and secure using Velcro straps.
- Position PVC bag over awning and zip up to complete pack down.

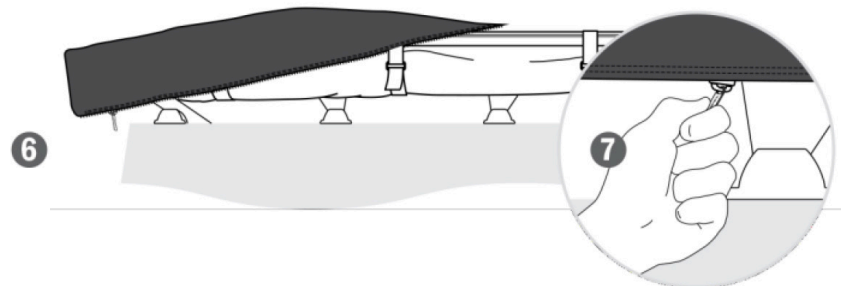
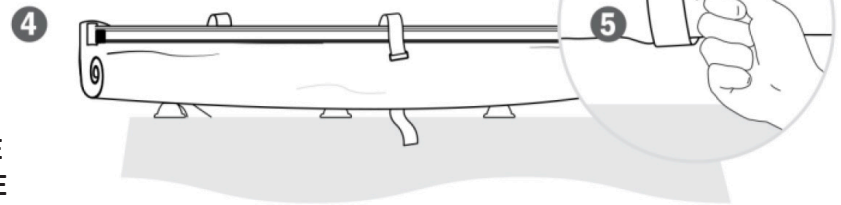
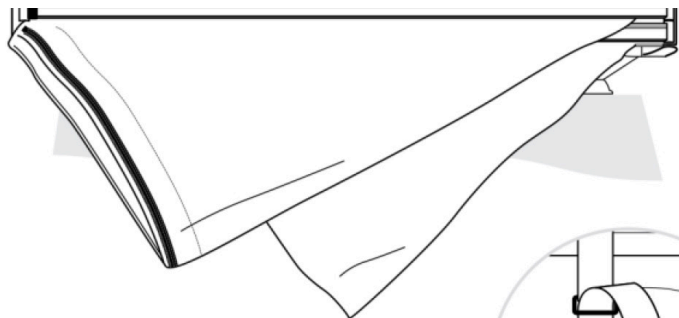
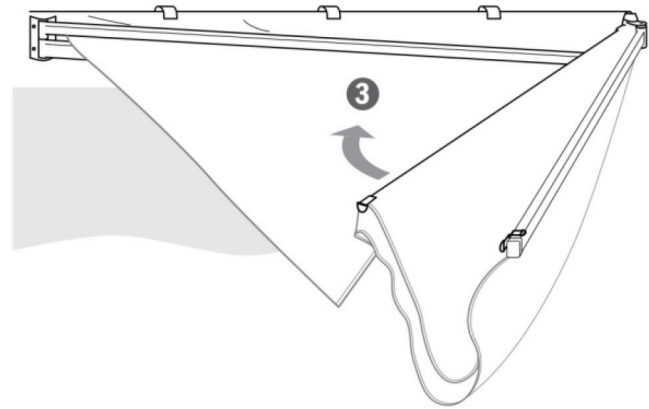
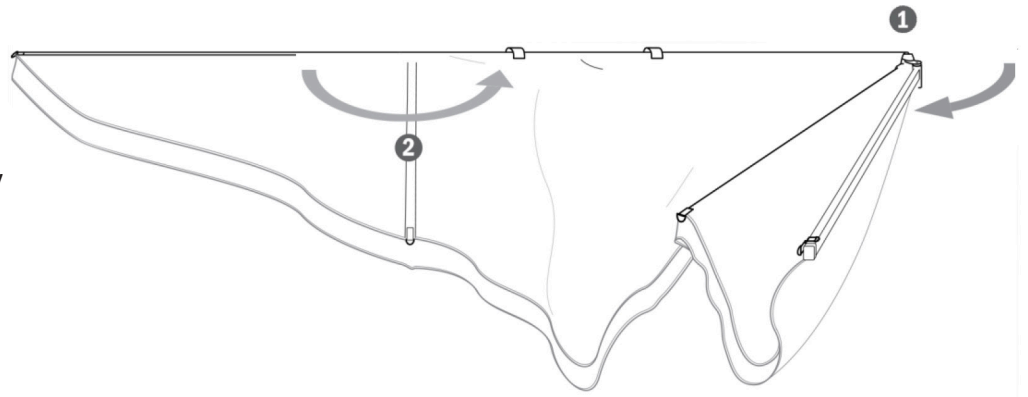

DO NOT STOW THE CANVAS CARRY BAG CONTAINING THE ADDITIONAL LEGS INSIDE THE AWNING'S TRANSIT COVER.



Nomadic 270° Awning

SET-UP & CARE INSTRUCTIONS

CLEANING

Clean with cold water and a soft bristle brush. Do not use soaps and detergents. Do not expose to petrol, diesel, oils or chemicals of any nature.

STORING

Correct storage is vital for the longevity of your Nomadic 270° awning. If on occasion the awning is required to be stowed wet, it is essential it is unpacked and dried as soon as possible. Rot, mildew damage and incorrect storage is not covered under warranty.

STRUCTURAL INTEGRITY

The 270° awning has been designed for general camping use under normal conditions. Always ensure all guy ropes are anchored correctly. It may be necessary to re-adjust guy ropes and pegs at times to maintain the structural integrity of the awning.

VEHICLE FITTING

We recommend using an experienced aftermarket 4x4 accessories fitter to mount the 270° Awning to your vehicle. Fasteners and fixing connections should be checked regularly on both the awning and roof rack to ensure the awning is always mounted securely to your vehicle roof rack. Prolonged travelling on uneven rough or corrugated terrain will require more frequent inspections.

FIXING THE OPTIONAL WALLS

The zip on awning walls will provide a sheltered / protected area around the awning. When attached to the awning, they are designed to create a shaded area and help reduce dust.

WARNINGS

- THE 270° AWNING HAS BEEN DESIGNED FOR GENERAL CAMPING USE UNDER NORMAL CONDITIONS. ALWAYS ENSURE ALL GUY ROPES ARE ANCHORED CORRECTLY. IT MAY BE NECESSARY TO RE-ADJUST GUY ROPES AND PEGS AT TIMES TO MAINTAIN THE STRUCTURAL INTEGRITY OF THE AWNING.
- TO AVOID CHANCES OF PERSONAL INJURY AND PROPERTY DAMAGE, WE HIGHLY RECOMMEND THE NOMADIC 270° AWNING SHOULD NOT BE ERECTED DURING WINDY CONDITIONS.
- * IN WINDY CONDITIONS IT IS HIGHLY RECOMMENDED NOT TO ERECT THE AWNING AND WALLS AS PERSONAL INJURY AND OR PROPERTY DAMAGE MAY OCCUR.
- DO NOT CUT OR MODIFY THE AWNING OR MOUNTING ACCESSORIES.
- DO NOT EXCEED THE VEHICLE MANUFACTURER'S WEIGHT LIMITS.
- DO NOT USE DAMAGED OR EXCESSIVELY WORN PRODUCTS. CONTACT US IF YOU ARE UNSURE.
- KEEP ALL FLAMES AND HEAT SOURCES AWAY FROM THE FABRIC
- UNDER NO CIRCUMSTANCES SHOULD ANY NAKED FLAME SOURCES BE USED NEAR THE AWNING, KEEP FIRES AWAY FROM THE AWNING
- KEEP A LOOK OUT FOR ANY AIRBORNE BURNING EMBERS THAT MAY COME IN CONTACT WITH THE TENT. KEEP A FIRE EXTINGUISHER OR BUCKET OF WATER NEAR BY.
- DO NOT OPERATE ANY DEVICES WHICH BURN FUEL INSIDE THE AWNING WHILE THE WALLS ARE ATTACHED.
- KEEP EXITS CLEAR
- REMAIN CAUTIOUS WHEN GUIDE ROPES ARE IN USE
- KEEP AN EYE OUT FOR CHILDREN WHEN AWNING IS IN USE
- STOW AWAY AWNING BEFORE OPERATING VEHICLE



DO YOU NEED OUR HELP?



CUSTOMER SUPPORT 833-226-4863



SALES@OVERLANDVEHICLESYSTEMS.COM

WANT TO SHOW US YOUR RIG?
CHECK OUT OUR SOCIAL!

@overlandvehiclesystems

